

Hiab XS 244 CLX

Capacity 22 tm



Hiab XS 244 CLX Basic data

Technical data

	EP-2 CLX	EP-3 CLX	EP-4 CLX	EP-5 CLX
Max. lifting capacity (kNm)	214	208	203	199
Outreach - hydraulic extensions (m)	8.0	10.3	12.7	15.1
Outreach - manual extensions (m)	12.5	14.9	17.2	17.2
Outreach / Lifting capacity, standard (m / kg)	2.5 / 8400	2.5 / 8200	2.4 / 8200	2.4 / 8200
	4.2 / 5200	4.3 / 4950	4.4 / 4700	4.5 / 4500
	5.9 / 3700	6.0 / 3450	6.1 / 3250	6.2 / 3100
	7.9 / 2760	8.0 / 2540	8.1 / 2380	8.2 / 2220
	-	10.2 / 1980	10.3 / 1820	10.4 / 1680
	-	-	12.6 / 1460	12.7 / 1340
	-	-	-	15.0 / 1120
Slewing angle	410°	410°	410°	410°
Height in folded position (mm)	2335	2335	2335	2335
Width in folded position (mm)	2429	2495	2495	2500
Installation space needed (mm)	1195	1185	1242	1192
Weight - "standard" crane without stabilizers (kg)	2390	2590	2760	2900
Weight - stabilizer equipment (kg)	381 - 474	381 - 474	381 - 474	381 - 474

Hiab XS 244 EP-5 CLX

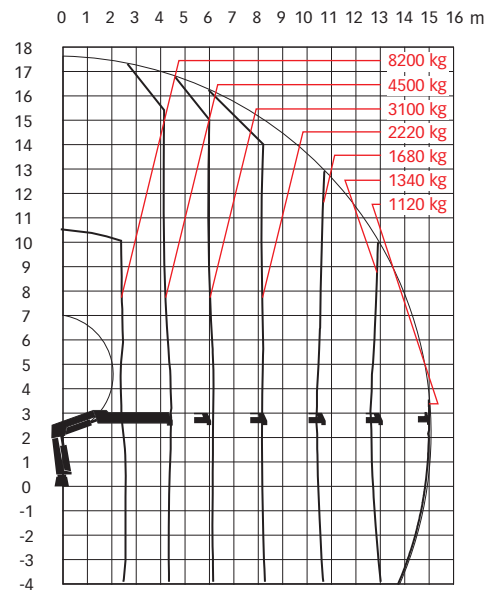
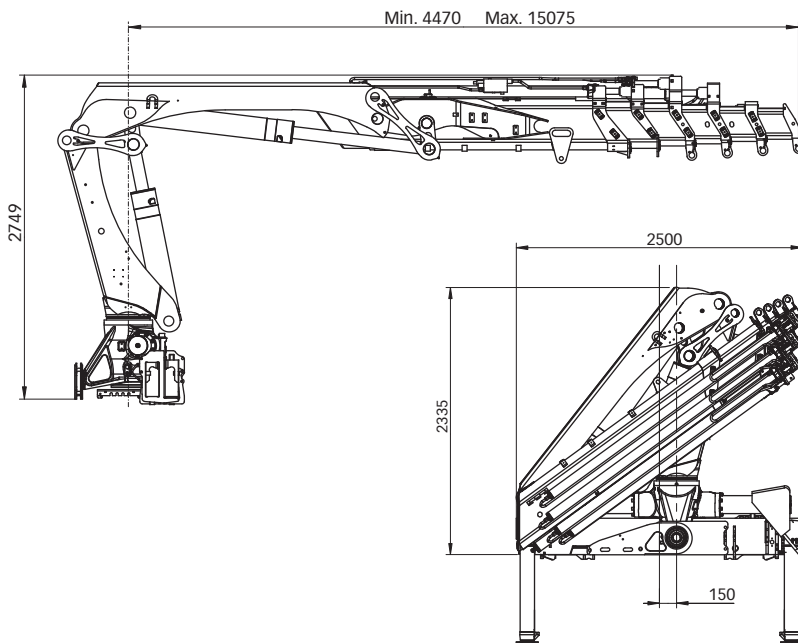

Disclaimer. Hiab cranes have been built to meet the highest standards of safety and service life and have been thoroughly tested. Strength calculations for this model have been carried out in accordance with EN13001 in fatigue class S2. Cargotec's certified Quality Assurance System complies with ISO 9001. Some of the items in our literature may be extra equipment. Certain applications may require an official permit. We reserve the right to change technical specifications without prior notice. Hiab cranes produced for EU-countries are CE-marked and comply with the European Standard EN 12999.

Cargotec improves the efficiency of cargo flows by offering solutions for the loading and unloading of goods on land and at sea – wherever cargo is on the move. Cargotec's main daughter brands for cargo handling Hiab, Kalmar and MacGregor are global market leaders in their fields. www.cargotec.com